

OPERATING AND MAINTENANCE MANUAL

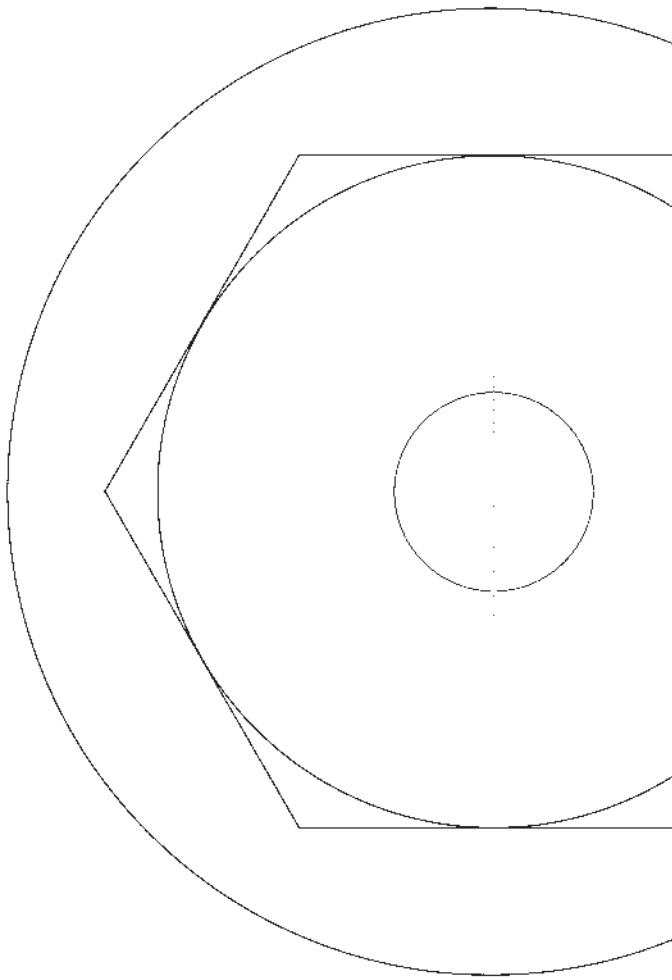

TYPHOON



Grazie per aver scelto un prodotto PAOLI.

*Dietro il vostro prodotto ci sono
la capacità e l'impegno di un team aziendale
che lavora tutti i giorni per essere in grado di offrirvi sempre
dei prodotti potenti, affidabili e durevoli nel tempo.*

*Dalle Pit Lanes a ogni tipo di attività,
il vostro successo è il nostro obiettivo!*

Thanks for choosing a PAOLI product.

*Behind your product you have
the capacity and the diligence of a company team
which is working all the days to be able to offer you always
powerful, reliable and long lasting products.*

*From the Pit Lanes to any businesses,
your success is our goal!*



General Power Tool Safety Warnings

WARNING

Read all safety warnings and all instructions. Failure to follow the warnings and instructions may result in electric shock, fire and/or serious injury. **Save all warnings and instructions for future reference!** The term "power tool" in the warnings refers to your mains-operated (corded) power tool or battery-operated (cordless) power tool.

1. Work area safety

- a. **Keep work area clean and well lit.** Cluttered or dark areas invite accidents.
- b. **Do not operate power tools in explosive atmospheres, such as in the presence of flammable liquids, gases or dust.** Power tools create sparks which may ignite the dust or fumes.
- c. **Keep children and bystanders away while operating a power tool.** Distractions can cause you to lose control.

2. Electrical safety

- a. **Power tool plugs must match the outlet. Never modify the plug in any way. Do not use any adapter plugs with earthed (grounded) power tools.** Unmodified plugs and matching outlets will reduce risk of electric shock.
- b. **Avoid body contact with earthed or grounded surfaces, such as pipes, radiators, ranges and refrigerators.** There is an increased risk of electric shock if your body is earthed or grounded.
- c. **Do not expose power tools to rain or wet conditions.** Water entering a power tool will increase the risk of electric shock.
- d. **Do not abuse the cord. Never use the cord for carrying, pulling or unplugging the power tool. Keep cord away from heat, oil, sharp edges or moving parts.** Damaged or entangled cords increase the risk of electric shock.
- e. **When operating a power tool outdoors, use an extension cord suitable for outdoor use.** Use of a cord suitable for outdoor use reduces the risk of electric shock.
- f. **If operating a power tool in a damp location is unavoidable, use a residual current device (RCD) protected supply.** Use of an RCD reduces the risk of electric shock.
- g. **Hold power tool by insulated gripping surfaces, when performing an operation where the fastener may contact hidden wiring or its own cord.** Fasteners contacting a "live" wire may make exposed metal parts of the power tool "live" and could give the operator an electric shock.

3. Personal safety

- a. **Stay alert, watch what you are doing and use common sense when operating a power tool. Do not use a power tool while you are tired or under the influence of drugs, alcohol or medication.** A moment of inattention while operating power tools may result in serious personal injury.
- b. **Use personal protective equipment. Always wear eye protection.** Protective equipment such as dust mask, non-skid safety shoes, hard hat, or hearing protection used for appropriate conditions will reduce personal injuries.
- c. **Prevent unintentional starting. Ensure the switch is in the off-position before connecting to power source and/or battery pack, picking up or carrying the tool.** Carrying power tools with your finger on the switch or energizing power tools that have the switch on invites accidents.

- d. **Remove any adjusting key or wrench before turning the power tool on.** A wrench or a key left attached to a rotating part of the power tool may result in personal injury.
 - e. **Do not overreach. Keep proper footing and balance at all times.** This enables better control of the power tool in unexpected situations.
 - f. **Dress properly. Do not wear loose clothing or jewelers. Keep your hair, clothing and gloves away from moving parts.** Loose clothes, jewelers or long hair can be caught in moving parts.
 - g. **If devices are provided for the connection of dust extraction and collection facilities, ensure these are connected and properly used.** Use of dust collection can reduce dust related hazards.
- 4. Power tool use and care**
- a. **Do not force the power tool. Use the correct power tool for your application.** The correct power tool will do the job better and safer at the rate for which it was designed.
 - b. **Do not use the power tool if the switch does not turn it on and off.** Any power tool that cannot be controlled with the switch is dangerous and must be repaired.
 - c. **Disconnect the plug from the power source and/or the battery pack from the power tool before making any adjustments, changing accessories, or storing power tools.** Such preventive safety measures reduce the risk of starting the power tool accidentally.
 - d. **Store idle power tools out of the reach of children and do not allow persons unfamiliar with the power tool or these instructions to operate the power tool.** Power tools are dangerous in the hands of untrained users.
 - e. **Maintain power tools. Check for misalignment or binding of moving parts, breakage of parts and any other condition that may affect the power tool's operation. If damaged, have the power tool repaired before use.** Many accidents are caused by poorly maintained power tools.
 - f. **Keep cutting tools sharp and clean.** Properly maintained cutting tools with sharp cutting edges are less likely to bind and are easier to control.
 - g. **Use the power tool, accessories and tool bits etc. in accordance with these instructions, taking into account the working conditions and the work to be performed.** Use of the power tool for operations different from those intended could result in a hazardous situation.
- 5. Battery tool use and care**
- a. **Recharge only with the charger specified by the manufacturer.** A charger that is suitable for one type of battery pack may create a risk of fire when used with another battery pack.
 - b. **Use power tools only with specifically designated battery packs.** Use of any other battery packs may create a risk of injury and fire.
 - c. **When battery pack is not in use, keep it away from other metal objects, like paper clips, coins, keys, nails, screws or other small metal objects that can make a connection from one terminal to another.** Shorting the battery terminals together may cause burns or a fire.
 - d. **Under abusive conditions, liquid may be ejected from the battery; avoid contact. If contact accidentally occurs, flush with water. If liquid contacts eyes, additionally seek medical help.** Liquid ejected from the battery may cause irritation or burns.
- 6. Service**
- a. **Have your power tool serviced by a qualified repair person using only identical replacement parts.** This will ensure that the safety of the power tool is maintained.

Product Safety Instructions

WARNING

1. To ensure the designed operational integrity of power tools, do not remove installed cover or screws.
2. Use your tool at lower input than specified on the nameplate, otherwise, the finish may be spoiled and working efficiency reduced by motor overload.
3. Do not wipe plastic parts with solvent. Solvents such as gasoline, thinner, benzene, carbon tetrachloride, alcohol, ammonia and oil containing chloric annex may damage and crack plastic parts. Do not wipe them with such solvent. Wipe plastic parts with a soft cloth lightly dampened with soap water.
4. Use clamps or other practical way to secure and support the work piece to a stable platform. Holding the work by hand or against your body is unstable and may lead to a loss of control.
5. Use only accessories that are recommended by the manufacturer for your model. Accessories that may be suitable for one tool may create a risk of injury when used on another tool.

Important Safety Instructions For Charger & Battery Pack

WARNING

1. Caution: To reduce risk of injury, charge only specific type rechargeable battery packs. Other types of battery packs may burst causing personal injury and damage.
2. Before using charger, read all instructions and cautionary markings on battery packs and chargers.
3. Do not expose charger to rain or snow.
4. To reduce the risk of damage to electric plug and cord, pull by plug rather than cord when disconnecting charger.
5. Use of an attachment not recommended or sold by the charger manufacture may result in a risk of fire, electric shock, or injury to persons.
6. Make sure cord is located so that it will not be stepped on, tripped on, tripped over, or otherwise subjected damage or stress.
7. Do not operate charger with damaged cord or plug. Replace them immediately.
8. Do not operate charger if it has received a sharp blow, been dropped, or otherwise damage in any way, take it to qualified center.
9. To reduce risk of electric shock, unplug charger from outlet before attempting any maintenance or cleaning. Turning off controls will not reduce this risk.
10. Do not disassemble charger or battery pack, take it to a qualified service center while repair is required. Incorrect reassembling may result in a risk of electric shock or fire.

Additional Safety Rules For Charger & Battery Pack

WARNING

1. Do not charge battery pack when temperature is below 0°C (32°F) or above 40°C (104°F).
2. Do not attempt to use a set-up transformer, an engine generator or DC power receptacle.
3. Do not allow anything to cover or clog the charger vents.
4. Always cover the battery pack terminals with the battery pack cover when the battery pack: is not used.
5. Do not short the battery pack.
6. Do not touch the terminals with any conductive material.
7. Avoid storing battery pack in a container with other metal objects such as nails, coins, etc.
8. Do not expose battery pack to water or rain, A battery pack short can use large current flow, overheating, possible burns and even a breakdown.
9. Do not store the machine and battery pack in locations where the temperature may reach or exceed 50°C (122°F)
10. Do not incinerate the battery pack even if it is severely damaged or completely worn out. The battery pack can explode in a fire.
11. Be careful not drop, shake or strike battery pack.
12. Do not charge inside a box or container of any kind. The battery pack must be placed in a well ventilated area during charging.
13. Do not leave batteries unused for extended period of time. Recharge the battery every 3~6 months and bring Li-Ion battery to 40~80% charge level before storage.
14. Li-Ion batteries are sensitive to high temperature and should be kept in a cool, dry and out of direct light exposure. Ideal temperature for operation and storage is below 25°C (77°F).
15. For extension of the battery lifetime, the lithium-ion battery is designed with the protection function to stop the output.
In the case of described below, when using this product, even if you are pulling the switch, the motor may stop.
This is not malfunction but the result of protection function.
 - When the battery power remaining runs out, the motor stops.
 - If the tool is overloaded, the motor may stop.
In this case, release the switch of tool and eliminate causes of overloading. After that you can use it again.
 - If the battery is overheated under overload work, the battery power may stop. In this case stop using the battery and let the battery cool. After that you can use it again.
16. This product is designed with low voltage protection, which prevents the tool from over discharging and prolongs battery's lifespan.

Specific Safety Rules and/or Symbols



-----Recycle



-----Class II Tool



-----Do Not Throw In Garbage

V-----Volts

a.c.-----Alternating Current

Hz-----Hertz

W-----Watts

kg-----Kilograms

mm-----Millimeter

d.c. ----Direct Current

kg-cm--Kilograms - Centimeter

ft-lb-----Foot-Pound

/min-----Revolutions or Reciprocations Per Minute

Specifications

Square drive	1/2"	3/4"
Voltage	20 V d.c.	
No-Load Speed(/min)	0~1650 r.p.m.(/min)	
Impacts Per Minute	2100	
Max Torque	8980kg-cm/ 880N.m/650ft-lb	10200kg-cm/ 1000N.m/738ft-lb
Tool Weight	2.9 kg	2.91 kg
Battery Weight	0.65 kg	
CHARGING TIME	45-60 Minutes Auto Cut-Off	
Vibration Level (EN 60745)	5,58 m/s ² (K=1,5 m/s ²)	
Sound Pressure Level (EN 60745)	94.9 dB(A) (KpA=3 dB)	
Sound Power Level (EN 60745)	105,9 dB(A) (KpA=3 dB)	

View the Major Components



1	Anvil
2	Main Switch
3	Battery Knob
4	Battery Pack
5	Forward/Reverse Rod
6	Fuel Gauge (Optional)

Operating Instructions (Slide-In)

Installing or Removing Battery Pack

1. Always switch off the machine before insertion or removal of the battery pack.
2. To remove the battery pack, push the button on the battery pack and pull the tool unit from the battery pack in the direction.
3. To insert the battery pack, align the tool unit slides with the battery pack sliding groove and push the tool unit into place.
The tool unit can be slide into battery pack in two directions.
4. Do not force the battery pack in sliding it into tool unit. If the battery pack does not slide in easily, it is not being inserted correctly.

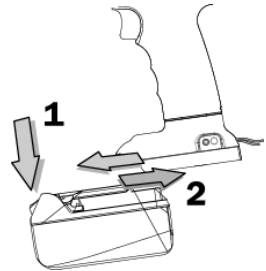





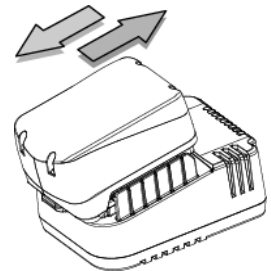

Charging the Battery Pack

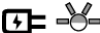
1. Connect the plug to the charger before charging.
2. Plug the fast charger into the power source.
3. Slide the battery pack into the charger as the arrow direction shown on the charger.
4. Push the battery pack into place and make sure the red light on the charger is “ON”. The battery pack is now starting the charging cycle.
5. After finish the charging cycle, the light will turn into green. The battery pack is now ready for use.
6. Your new battery pack is not charged. You need to charge it before use.
7. If you try to charge a battery pack from a just-operated machine, sometimes the charging light will not come on. If this occurs, let the battery pack cool for a while then re-insert it and try to charge again.
8. When you charge a new battery pack or a battery pack which has not been used for a long period, it may not accept a full charge. This is a normal condition and does not indicate a problem. You can recharge the battery pack fully after discharging it completely a couple of times.
9. Unplug the charger from the power source after finish the charge.
10. Please remove the battery from the unplugged charger for storage.

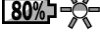





The LED Light on the Charger

-  Power On (Green light flashes slowly)
-  Battery Low (Red light stays illuminated)
-  Battery charged 80% (Green light flashes rapidly)
-  Battery charged 100% (Green light stays illuminated)
-  Battery Pack temperature is too hot or too cold (Red light flashes slowly)
-  Battery Pack malfunction (Red and Green lights stay illuminated)

Battery Pack LED Indication Function(Optional)

The Battery Pack has a “SW” button and 4-step green LEDs for indicating remaining capacity status. The fuel gauge green LED will indicate when the “SW” button is momentarily pressed.

Remaining Capacity LED Indication	RC Status
LED 1 (green) 	0%- 25%
LED 1, 2 (green) 	26%-50%
LED 1, 2, 3 (green) 	51%-75%
LED 1, 2, 3, 4 (green) 	76%-100%

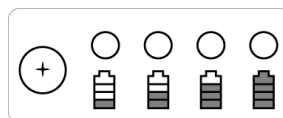

WARNING

1. Charger is plugged into a 100-240V a.c outlet only.
2. If the battery pack is too hot or too cold, the charger will not fast charge the battery pack and the red Indicator light is “blinking”. When the battery pack temperature returns to between 0°C(32°F) and 50°C(122°F), The charger will automatically begin charging.
3. If both red and green indicator lights are “ON” the battery pack either does not comply or is defective. Please contact your retailer.
4. Do not charge the battery pack in the rain, snow or high temperature environment.
5. Do not charge battery pack when environment temperature is below 0°C (32°F) or above 40°C(104°F)
6. While charge the cool battery pack (below 0°C) in the warm indoor, keep the battery pack in the room for one hour to warm up before starting the battery pack.
7. Remove the plug after finishing the charge.
8. The charger should be cooled at least one hour after continue charging three times.
9. Do not use generator for charging the battery pack.

Tool Operation

Installing Or Removing Socket

Always be sure that the machine is switched off and the battery pack is removed before installing or removing the socket.

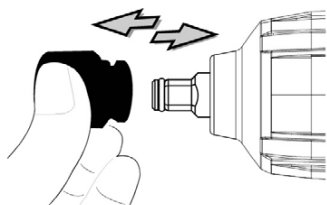

Fig.4

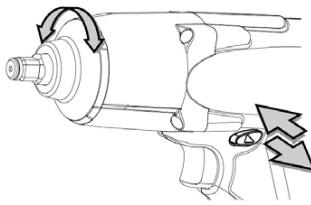

Fig.5

Caution

1. To install the socket, push the socket into the driving spindle as far as it will go.
(See Fig.4)
2. To remove the socket, simply pull the socket from the driving spindle.
3. To start the machine, simply pull the main switch. Machine speed is increase by increasing pressure on the main switch. Release the main switch to stop.
4. For reversing the machine, (See Fig.5) use the forward / reverse rod on the drive unit. The directions of the rotation are also shown on the face of the bar.
5. Always check the direction of rotation before operation.
6. Use the forward / reverse rod only after the machine come to a complete stop.
Changing the direction of rotation before the machine stops may damage the machine.
7. Hold the machine firmly and place the point of driver socket in the nut.
Apply forward pressure to the machine to the extent that the socket will not slip off the nut and turn the machine on to start operation.
 - Use the proper socket for the nut that you wish to use.
 - Hold the machine pointed straight at the nut. If you tighten the nut for a time longer than it needs, the nut or the point of the driver socket may be overstressed, stripped, damaged, etc. Before starting your job, always perform a test operation to determine the proper tightening time for your screw. When tightening a standard nut in a steel plate, the proper tightening torque can be obtained in an extremely short time.
 - Turn the machine off as soon as the impact sound is heard. When tightening nut M6 or smaller, carefully adjust pressure on the main switch so that the nut is not damaged.
8. The tightening torque is affected by a wide variety of factors including the following. After tightening always check the torque with a torque wrench.
 - When the battery pack is discharged almost completely, voltage will drop and the tightening torque will be reduced.
 - Driver bit or socket bit:
Failure to use the correct size driver bit or socket bit will cause a reduction in the tightening torque.

- For driving a bolt:

Even though the torque coefficient and the class of bolt are the same, the proper tightening torque will differ according to the diameter of the bolt.

9. Even the diameter of the bolt are same, the proper tightening torque will differ according to the torque coefficient, the class of the bolt and the bolt length.
10. The manner of holding the machine or the material of driving position to be tightened will affect the torque.

This product complies with EU Directive 2012/19/EC

- ▷ The crossed bin symbol on the appliance indicates that the product at the end of its life, must be disposed of separately from domestic waste, either by taking it to a separate waste disposal site for electric and electronic appliances or by returning it to your dealer awhen you buy another similar appliance.
- ▷ The user is responsible for taking the appliance to a special waste disposal site at the end of its life, on penalty of the measures provided for by current legislation on waste.
- ▷ If the disused appliance is collected correctly as separate waste, it can be recycled, treated and disposed of ecologically; this avoids a negative impact on both the environment and health, and contributes towards the recycling of the product's materials.
- ▷ For further information regarding the waste disposal services available, contact your local waste disposal agency or the shop where you bought the appliance.
- ▷ The producers and importers meet their responsibilities for recycling, treatment and environmentally friendly disposal either directly or through participating in a collective system.



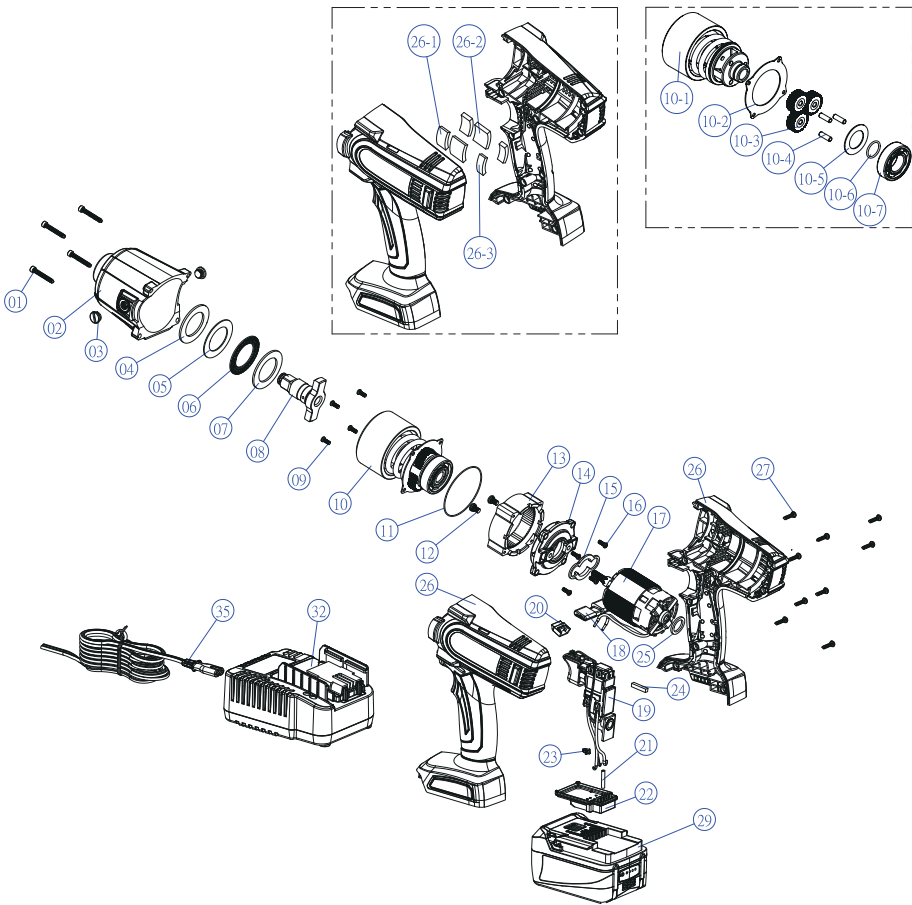

NO.	PARTS NAME	Q
1	SCREW	4
2	FRONT COVER ASS'Y	1
3	SCREW	2
4	RUBBER WASHER	1
5	WASHER	1
6	BEARING	1
7	WASHER	1
8	FRONT IMPACT ASS'Y	1
9	SCREW	4
10	REAR IMPACT ASS'Y	1
10-1	HAMMER ASS'Y	1
10-2	GASKET	1
10-3	PLANETARY GEARS	3
10-4	PLANETARY PIN	3
10-5	WASHER	1
10-6	O-RING	1
10-7	BEARING	1
11	O-RING	1
12	SCREW	2
13	RING GEAR	1
14	MOTOR CONNECTOR	1
15	RUBBER PAD	1
16	SCREW	4

NO.	PARTS NAME	Q
17	MOTOR ASS'Y	1
18	FORWARD/REVERSE ROD	1
19	MAIN SWITCH	1
20	LED	1
21	HEAT SHRINKAGE TUBE	1
22	BATTERY CONNECTOR	1
23	CABLE TIE	1
24	RUBBER CUSHION	1
25	SILICONE WASHER	1
26	HOUSING-L&R	1
26-1	RUBBER CUSHION	2
26-2	RUBBER CUSHION	2
26-3	RUBBER CUSHION	2
27	SCREW	9
29	BATTERY PACK	1
32	MINI CHARGER	1
35	POWER CORD	1

EC DECLARATION OF CONFORMITY

Individual machine

We

DINO PAOLI S.R.L. - Via G. Dorso, 5 - 42124 Reggio Nell'Emilia (Re) - Italy

declare under our sole responsibility that the product:

Machine Type

TYPHOON

Cordless impact wrench

TECHNICAL DATA

View Operating and Maintenance Manual at page 5

SERIAL NO.

View back cover

to which this declaration relates, is in conformity with the requirements of the Machinery Directive 2006/42/EC and EMC Directive 2004/108/EC

Name and address of the person authorized to draw up the technical file

Name: **Dr. Federico Galloni**

Address: **DINO PAOLI S.R.L. - Via G. Dorso, 5 - 42124 Reggio Nell'Emilia (Re) - Italy**

Name and position of issuer:

**Commercial Director &
Member of the Board of Directors**

Dr. Federico Galloni



Reggio nell'Emilia (RE) - Italy - March 1, 2017

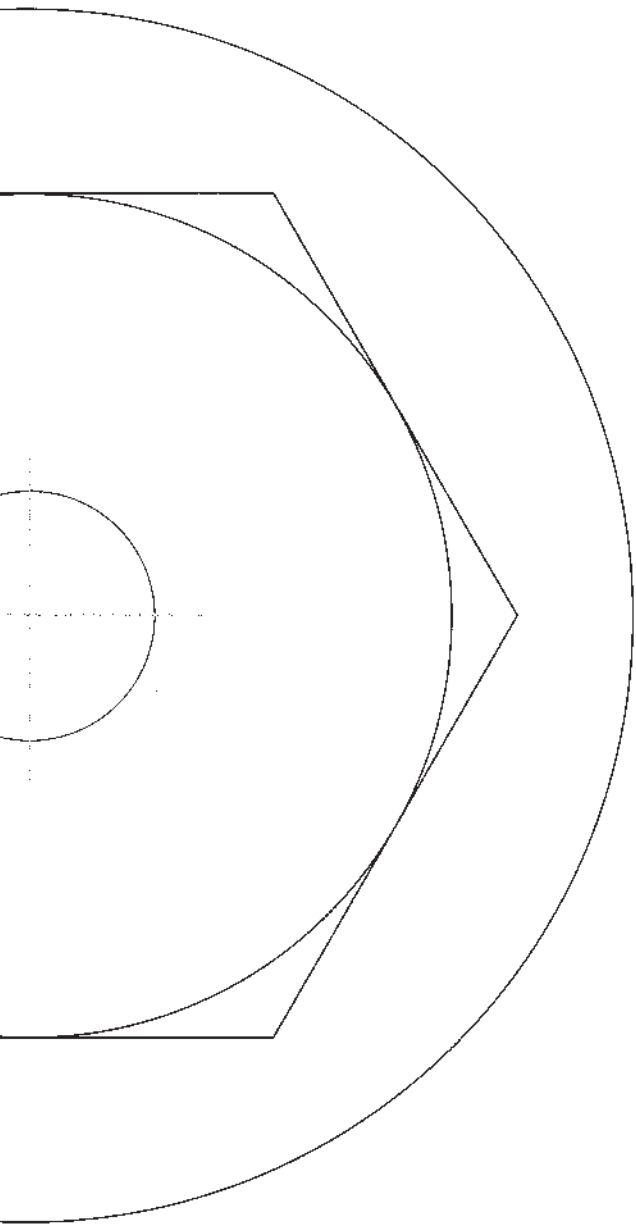

DINO PAOLI s.r.l.
Via G. Dorso, 5 - 42124 Reggio nell'Emilia (RE) - Italy
Phone +39 0522 364 511 - Fax +39 0522 304 864
info@paoli.net - www.paoli.net